

## Dual NPN+PNP Small Signal Transistor

### SOT-363

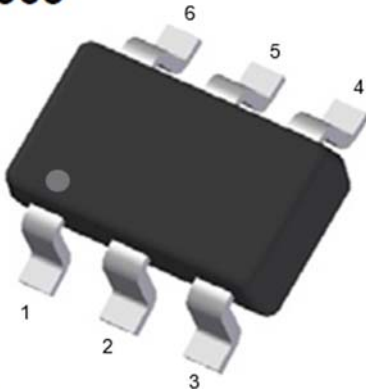

- 1、 Emitter.
- 2、 base.
- 3、 collector
- 4、 Emitter
- 5、 base
- 6、 collector

### Features

- Epoxy meets UL-94 V-0 flammability rating
- Surface mount package ideally Suited for Automatic Insertion
- Moisture Sensitivity Level 1
- Part no. with suffix "Q" means AEC-Q101 qualified

### Mechanical Data

- **Package:** SOT-363
- **Terminals:** Tin plated leads, solderable per J-STD-002 and JESD22-B102
- **Marking:** K27

### Equivalent circuit

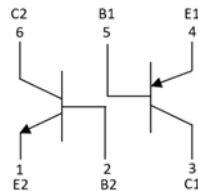

### ■TR1 PNP Pin3、 4、 5 Maximum Ratings (Ta=25°C Unless otherwise specified)

ITEM	SYMBOL	UNIT	CONDITIONS	VALUE
Collector-Base Voltage	$V_{CBO}$	V	$I_C = -10\mu A, I_E = 0$	-60
Collector-Emitter Voltage	$V_{CEO}$	V	$I_C = -10mA, I_B = 0$	-60
Emitter-Base Voltage	$V_{EBO}$	V	$I_E = -10\mu A, I_C = 0$	-5
Collector Current	$I_C$	mA		-600
Collector Power Dissipation	$P_C$	mW		200
Junction Temperature	$T_j$	°C		-55 to +150
Storage Temperature	$T_{stg}$	°C		-55 to +150

### ■TR2 NPN Pin1、 2、 6 Maximum Ratings (Ta=25°C Unless otherwise specified)

ITEM	SYMBOL	UNIT	CONDITIONS	VALUE
Collector-Base Voltage	$V_{CBO}$	V	$I_C = 10\mu A, I_E = 0$	75
Collector-Emitter Voltage	$V_{CEO}$	V	$I_C = 10mA, I_B = 0$	40
Emitter-Base Voltage	$V_{EBO}$	V	$I_E = 10\mu A, I_C = 0$	6
Collector Current	$I_C$	mA		600
Collector Power Dissipation	$P_C$	mW		200
Junction Temperature	$T_j$	°C		-55 to +150
Storage Temperature	$T_{stg}$	°C		-55 to +150



# MMDT2227Q

## ■TR1 PNP Pin3、4、5 Electrical Characteristics (Ta=25°C unless otherwise specified)

ITEM	SYMBOL	UNIT	CONDITIONS	MIN.	TYP.	MAX.
Collector-base breakdown voltage	$V_{CBO}$	V	$I_C = -10\mu A, I_E = 0$	-60		
Collector-emitter breakdown voltage	$V_{CEO}$	V	$I_C = -10mA, I_B = 0$	-60		
Emitter-base breakdown voltage	$V_{EBO}$	V	$I_E = -10\mu A, I_C = 0$	-5		
Collector-Base cut-off current	$I_{CBO}$	nA	$V_{CB} = -50V, I_E = 0$			-10
Collector cut-off current	$I_{CEX}$	nA	$V_{CE} = -30V, V_{EB(off)} = -0.5V$			-50
Emitter-Base Cut-off current	$I_{EBO}$	nA	$V_{EB} = -5V, I_C = 0$			-10
DC current gain	$h_{FE1}$		$V_{CE} = -10V, I_C = -0.1mA$	75		
	$h_{FE2}$		$V_{CE} = -10V, I_C = -1mA$	100		
	$h_{FE3}$		$V_{CE} = -10V, I_C = -10mA$	100		
	$h_{FE4}$		$V_{CE} = -10V, I_C = -150mA$	100		300
	$h_{FE5}$		$V_{CE} = -10V, I_C = -500mA$	50		
Collector-emitter saturation voltage	$V_{CE(sat)}$	V	$I_C = -150mA, I_B = -15mA$			-0.4
			$I_C = -500mA, I_B = -50mA$			-1.6
Baser-emitter saturation voltage	$V_{BE(sat)}$	V	$I_C = -150mA, I_B = -15mA$			-1.3
			$I_C = -500mA, I_B = -50mA$			-2.6
Transition frequency	$f_T$	MHz	$V_{CE} = -20V, I_C = -50mA, f = 100MHz$	200		
Delay time	$t_d$	ns	$V_{CC} = -30V, I_C = -150mA, I_{B1} = -15mA$			10
Rise time	$t_r$	ns				40
Storage time	$t_s$	ns	$V_{CC} = -6V, I_C = -150mA, I_{B1} = -I_{B2} = -15mA$			225
Fall time	$t_f$	ns				60



# MMDT2227Q

## ■TR2 NPN Pin1、2、6 Electrical Characteristics (Ta=25°C unless otherwise specified)

ITEM	SYMBOL	UNIT	CONDITIONS	MIN.	TYP.	MAX.
Collector-base breakdown voltage	$V_{CBO}$	V	$I_C = 10\mu A, I_E = 0$	75		
Collector-emitter breakdown voltage	$V_{CEO}$	V	$I_C = 10mA, I_B = 0$	40		
Emitter-base breakdown voltage	$V_{EBO}$	V	$I_E = 10\mu A, I_C = 0$	6		
Collector-Base cut-off current	$I_{CBO}$	nA	$V_{CB} = 60V, I_E = 0$			10
Collector cut-off current	$I_{CEX}$	nA	$V_{CE} = 60V, V_{EB(off)} = 3V$			10
Emitter-Base Cut-off current	$I_{EBO}$	nA	$V_{EB} = 3V, I_C = 0$			10
Base cut-off Current	$I_{BL}$	nA	$V_{CE} = 60V, V_{EB(off)} = 3V$			20
DC current gain	$h_{FE1}$		$V_{CE} = 10V, I_C = 0.1mA$	35		
	$h_{FE2}$		$V_{CE} = 10V, I_C = 1mA$	50		
	$h_{FE3}$		$V_{CE} = 10V, I_C = 10mA$	75		
	$h_{FE4}$		$V_{CE} = 10V, I_C = 150mA$	100		300
	$h_{FE5}$		$V_{CE} = 1V, I_C = 150mA$	35		
	$h_{FE6}$		$V_{CE} = 10V, I_C = 500mA$	40		
Collector-emitter saturation voltage	$V_{CE(sat)}$	V	$I_C = 150mA, I_B = 15mA$			0.3
			$I_C = 500mA, I_B = 50mA$			1
Baser-emitter saturation voltage	$V_{BE(sat)}$	V	$I_C = 150mA, I_B = 15mA$			1.2
			$I_C = 500mA, I_B = 50mA$			2
Transition frequency	$f_T$	MHz	$V_{CE} = 20V, I_C = 20mA,$ $f = 100MHz$	300		
Delay time	$t_d$	ns	$V_{CC} = 30V, I_C = 150mA,$ $I_{B1} = 15mA, V_{BE(off)} = -0.5V$			10
Rise time	$t_r$	ns				25
Storage time	$t_s$	ns	$V_{CC} = 30V, I_C = 150mA,$ $I_{B1} = I_{B2} = 5mA$			225
Fall time	$t_f$	ns				60

## ■ Ordering Information (Example)

PREFERRED P/N	PACKING CODE	UNIT WEIGHT(g)	MINIMUM PACKAGE(pcs)	INNER BOX QUANTITY(pcs)	OUTER CARTON QUANTITY(pcs)	DELIVERY MODE
MMDT2227Q	F2	Approximate 0.009g	3000	30000	120000	7" reel



# MMDT2227Q

## ■ TR1 PNP Pin3、4、5 Characteristics (Typical)

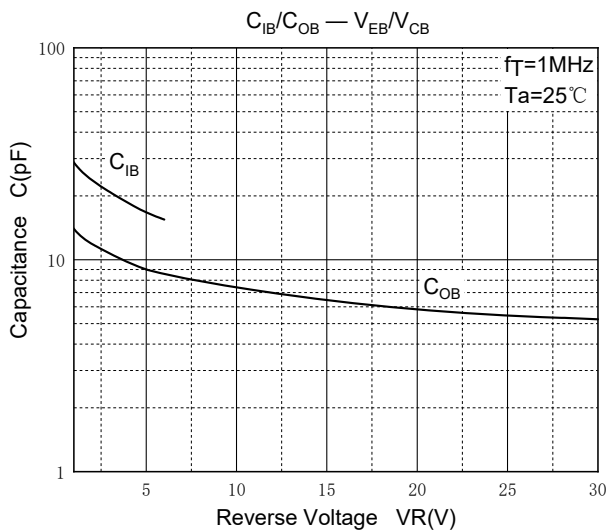
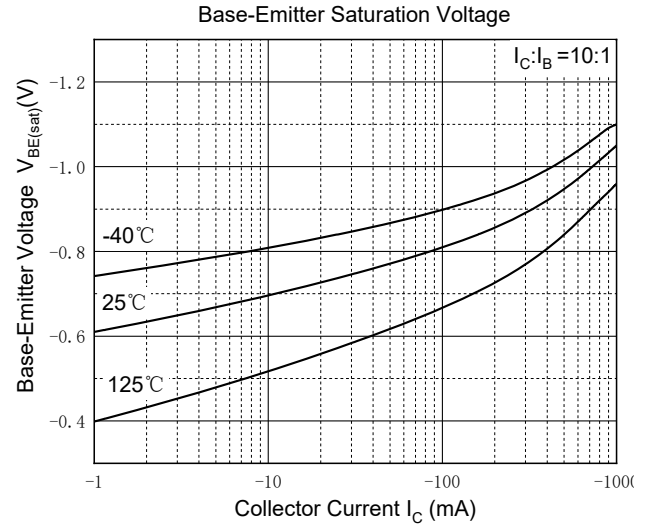
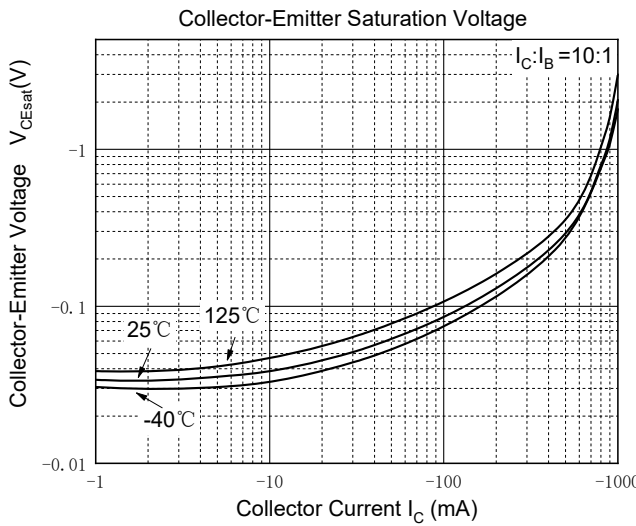
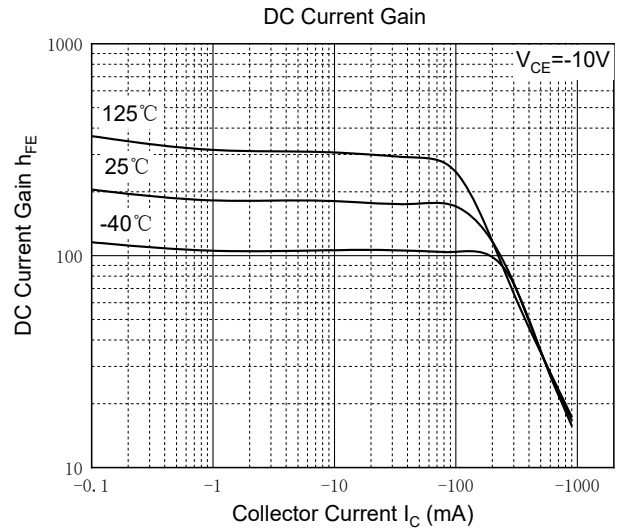
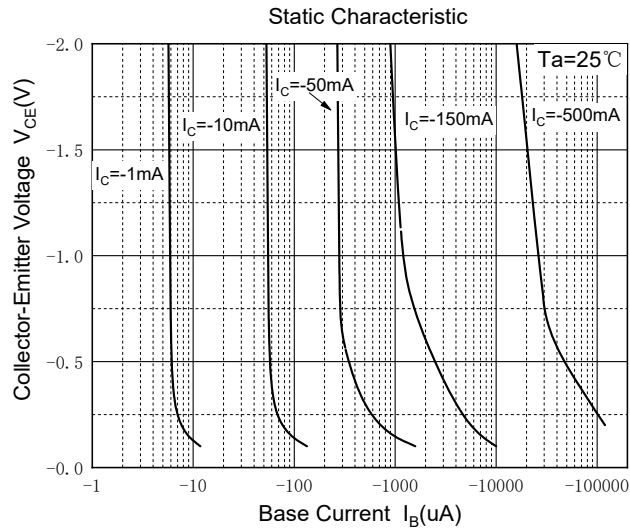



## ■ TR2 NPN Pin1、2、6 Characteristics (Typical)

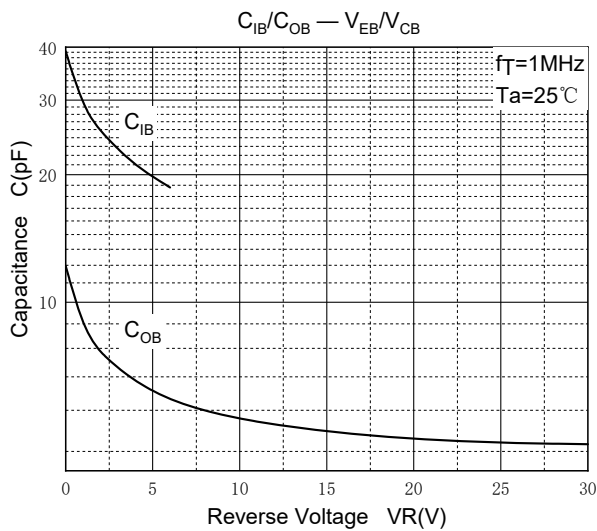
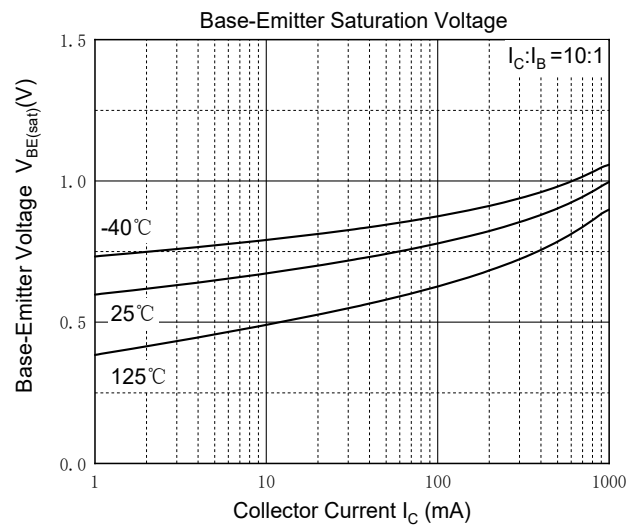
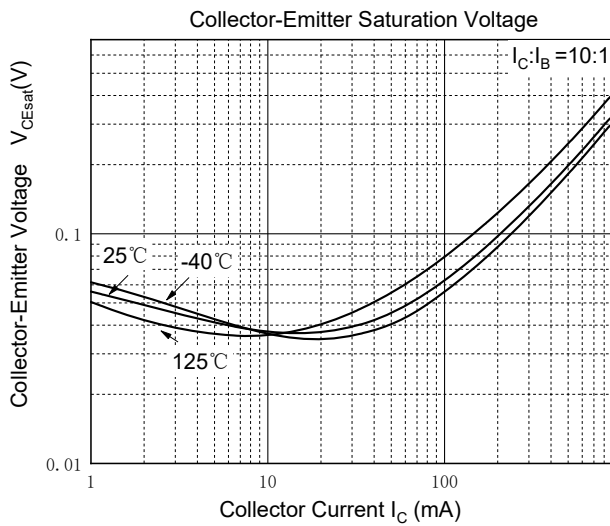
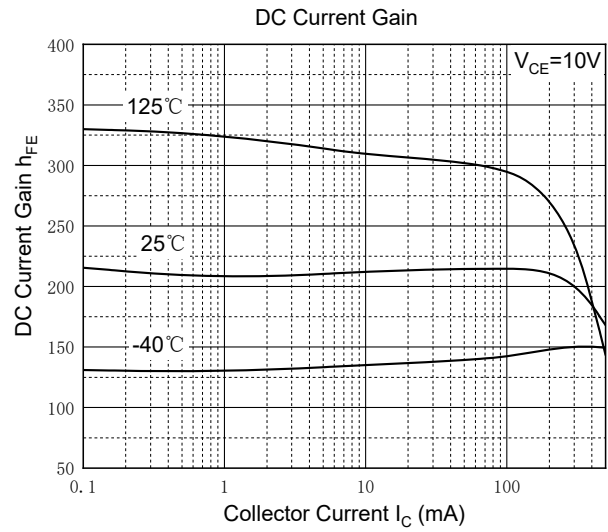
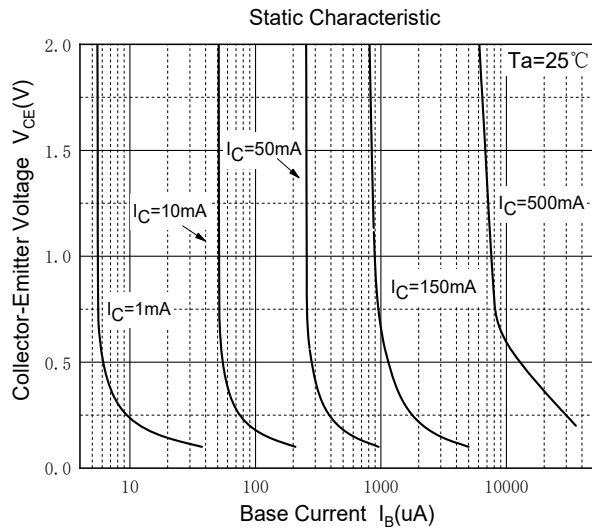



# MMDT2227Q

## ■SOT-363 Package Outline Dimensions

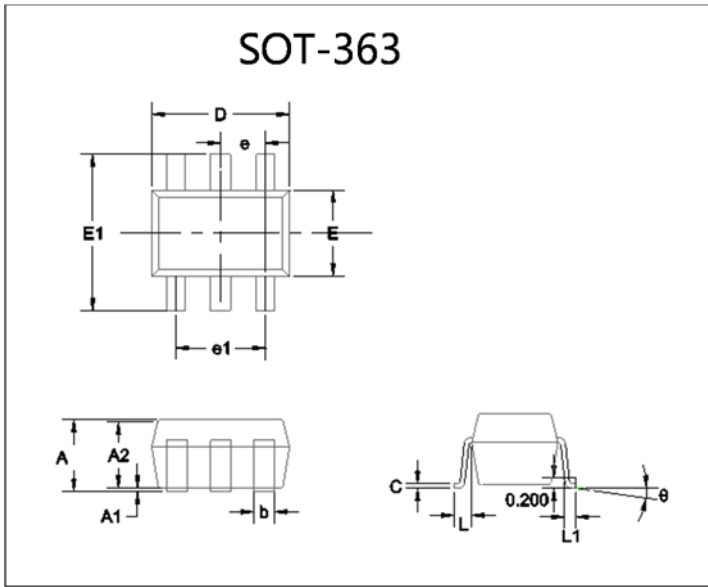

DIM	INCHES		MM		NOTE
	MIN	MAX	MIN	MAX	
A	0.035	0.043	0.90	1.10	
A1	0.000	0.004	0.00	0.10	
A2	0.035	0.039	0.90	1.00	
b	0.006	0.014	0.15	0.35	
c	0.002	0.010	0.05	0.25	
D	0.071	0.087	1.80	2.20	
E	0.045	0.053	1.15	1.35	
E1	0.085	0.096	2.15	2.45	
e	0.026Typ		0.65Typ		
e1	0.047	0.055	1.20	1.40	
L	0.021Typ		0.525Typ		
L1	0.010	0.018	0.26	0.46	
theta	0°	8°	0°	8°	

## ■SOT-363 Soldering Footprint

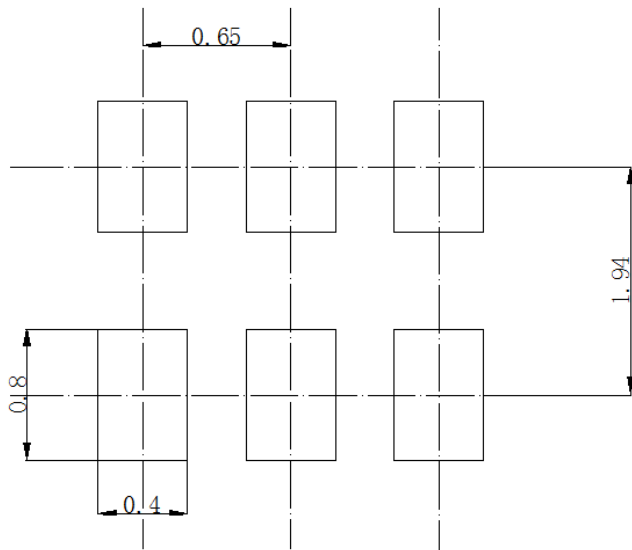

Unit: mm



## Disclaimer

The information presented in this document is for reference only. Yangzhou Yangjie Electronic Technology Co., Ltd. reserves the right to make changes without notice for the specification of the products displayed herein to improve reliability, function or design or otherwise.

The product listed herein is designed to be used with automotive electronics, are not designed for use in medical, life-saving, lifesustaining, or military, Yangjie or anyone on its behalf, assumes no responsibility or liability for any damages resulting from such improper use of sale.

This publication supersedes & replaces all information previously supplied. For additional information, please visit our website [http:// www.21yangjie.com](http://www.21yangjie.com) , or consult your nearest Yangjie's sales office for further assistance.